

HERRINGBONE INSTALLATION ENGINEERED SPC VINYL FLOORING



Furlong Flooring®
First choice flooring for every room

Before You Start / Preparations

To save time and avoid frustration. Please read all the instructions before you begin the installation
Improper installation will void the warranty.

Important Notice

- Always allow the product to acclimatise to the room in which it is being laid for at least 48 hours. It must be stored horizontally on a level surface, and the temperature must be between 18-25°C for at least 24hrs before, during and after the installation.
- Transport and store all flooring packs on a flat surface while keeping them in neat piles.
- The subfloor must be smooth and level with no more than 3mm deviation in any 2.0mtr run; check using a straight edge.
- Do **NOT** install heavy cabinets over the floor (that will pin it); install them around such objects. Always allow a 6mm expansion gap around the room's perimeter between the installation and any solid objects, such as skirting boards, radiator pipes and cabinets. An expansion gap is also required around and under doorways.
- For use over Water-based underfloor heating, ensure the heating element never exceeds 27°C. Turn off your system 48 hours before installation. Once installed, you can turn your system on again, starting at 15°C, increasing at a maximum of 5°C per day until a maximum of 27°C is reached. This flooring should **NOT** be installed over electrical underfloor heating.
- Visually inspect all panels before and during installation under optimal light conditions. Any defective panels must not be used, and any planks installed are deemed to be accepted and cannot be claimed under the product warranty.
- Make sure you check your flooring before starting installation. Ensuring you have the right product, the correct quantity (including cutting allowance), and no visible defects visible on your flooring. This will save you time later in the installation.
- Additional underlay is not required with products with a built-in underlay attached.
- For floor surfaces exceeding 100m², or greater than 10m in a single direction, you will need to add a transition profile to allow a 6mm expansion joint to be installed to have two smaller areas.

Tools Required:

For a successful installation, the following tools will be necessary:



Spacers



Soft Rubber
Mallet



Ruler

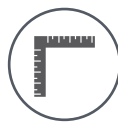

Set
Square



Pencil



Tape
Measure



Utility
Knife



Saw



Pull Bar



Tapping
Block

Disclaimer:

At the time of writing, all information is specified correctly. The manufacturer reserves the right to change the specifications of this product at any time without prior notice to third parties.

The photographs/illustrations in this document are only intended as a visual reference, and no rights can be derived from them.

You must ensure you use a suitable transition profile in your doorways. Installing as one floor between multiple rooms will void the manufacturers warranty.

Instructional Video:
How to install Engineered SPC Vinyl
Flooring with Unidrop Technology.



100% WATERPROOF AQUACORE BOARD

with **PROFLEX** Technology

UNIDROP
PATENTED TECHNOLOGY ®

HERRINGBONE INSTALLATION ENGINEERED SPC VINYL FLOORING



Furlong Flooring®
First choice flooring for every room

A Understanding Herringbone Assembly

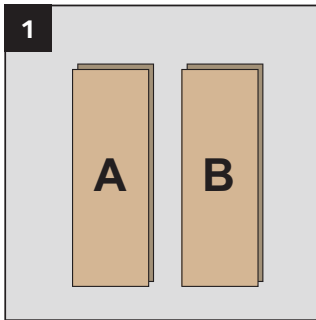

Each plank is marked "A" and "B" on the back of every board. Every box contains 50% "A" and 50% B planks.

To speed up installation and reduced errors, separate "A" and "B" planks into individual stacks from several packs of flooring. This will increase your installation speed.

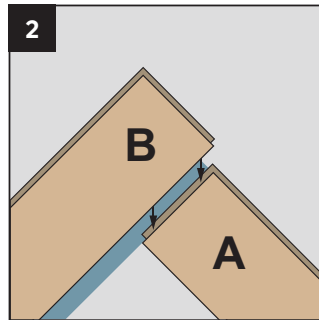

Position the long side of plank "B" over the short side of plank "A", so that the flooring can fit together without any gaps.

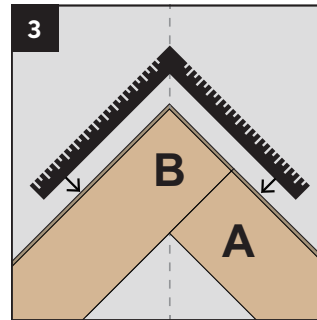

To ensure your boards are perfectly aligned at a 90* angle, we recommend using a set square when putting the first 2 rows together. It is critical to ensure you install your first few rows correctly for a successful installation.

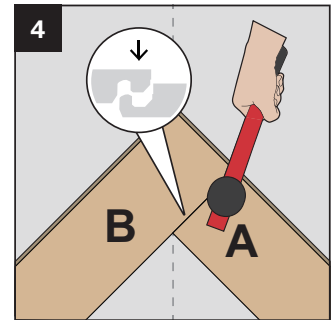

Using a soft rubber mallet, tap down gently on the joint between both boards. This will make sure your flooring is locked into place. The groove side of your planks must always face away from your starting wall.

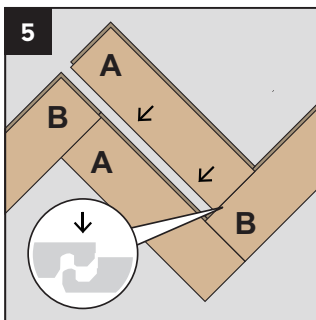

Take your next "A" board and insert the long tongue side into the previously installed "A" & "B" boards. Make sure your "A" board also overlaps the other "B" board perfectly so all joints are aligned.

Lower plank down while pushing it forward to engage long sides fully.

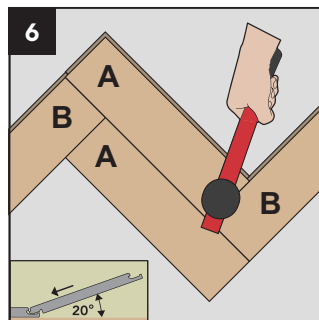

As done with the first 2 boards, use the soft rubber mallet to gently tap down on your boards to ensure the locking system is in the correct place.

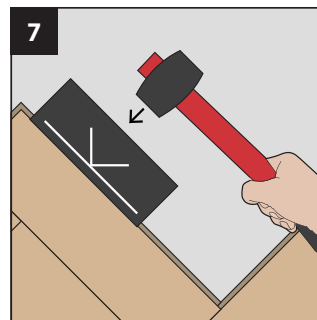

Use a tapping block along the long edge to close any small gaps between the rows. Tap gently to avoid damaging the product, this could impact on your installation.

100% WATERPROOF AQUACORE BOARD

with PROFLEX Technology

UNIDROP
PATENTED TECHNOLOGY ®

HERRINGBONE INSTALLATION ENGINEERED SPC VINYL FLOORING



Furlong Flooring®
First choice flooring for every room

B Building Starting Triangles

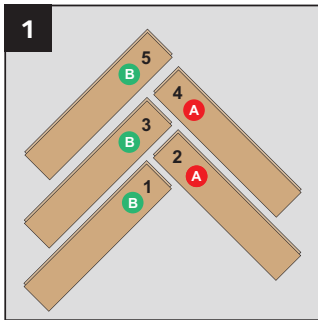

Take your "A" and "B" boards and position them as shown above.

Note - The number of "A" and "B" boards required will depend on how wide the boards are. You can adjust up and down as required.

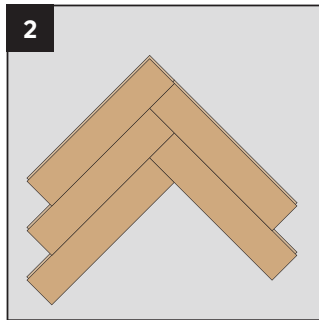

Install your "A" and "B" boards together as shown above. You must ensure no gapping between the joints is present. Refer to section A of these instructions as guidance should it be required.

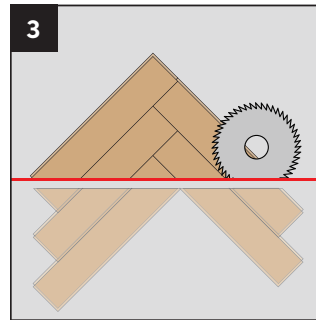

Use a straight edge to mark a line going across your flooring as shown above. This will create your triangle to start your installation. Depending on the type of saw you use, it might be easier to disassemble your flooring to start your installation. Do not throw away your waste, this can be used later in the installation.

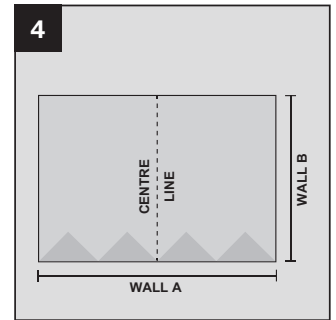

You can now repeat the process until you have the correct amount of triangles required for your installation. You might need to make extra triangles for the edges of your room. Choose the wall you wish to start your installation. Measure and mark a center line down the middle of your room.

Starting your Installation

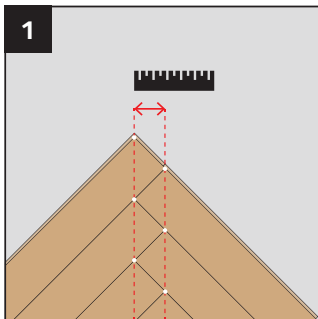

Measure the distance between the corners of your flooring, as shown on the picture above. Divide this number by 2, this will provide you with your installation value known as X.

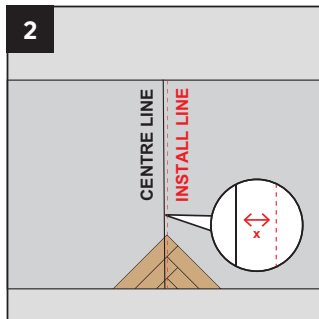

Mark the installation line on your sub-floor parallel to the center line as shown above. This should be at your X distance away from the center line.

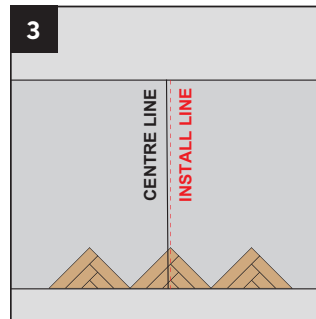

Lay out your starting triangles along the wall which you are installing from. Start by placing the point of your first triangle pointing up your installation line. Place your 6mm spacer behind the triangles to ensure the necessary expansion is left. Lay the rest of your triangles across the width of your starting wall with expansions behind each triangle.

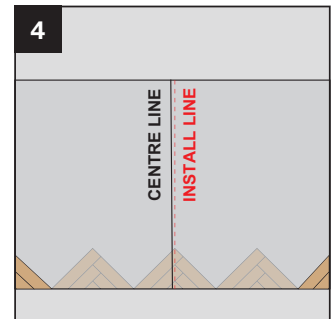

To finish your starting rows, measure the gap between your wall (including Spacer) and closest installed triangle. Mark this distance onto one of your triangles. Cut to size and position in place.

100% WATERPROOF AQUACORE BOARD

with PROFLEX Technology

UNIDROP
PATENTED TECHNOLOGY

HERRINGBONE INSTALLATION ENGINEERED SPC VINYL FLOORING



Furlong Flooring®
First choice flooring for every room

C Further Installation

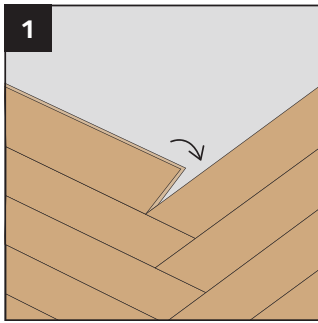

Each board needs to be locked into one another. To connect a new board you have to use a rubber mallet to gently engage the locking system.

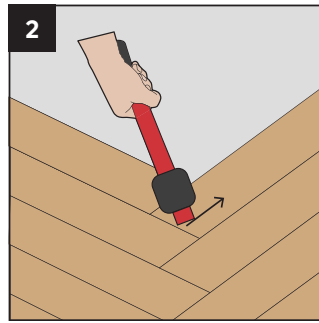

Using your rubber mallet gently tap down on each board during installation to connect the short side into the previous board. Start in the corner and work towards the opposite short side edge. A tapping block can also be used if required to close up slight gaps in the joins.

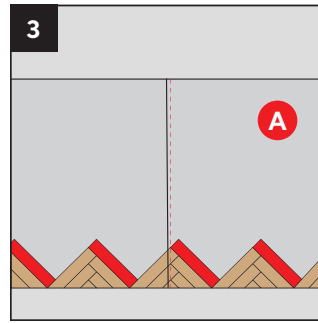

To connect your triangles together into one piece, start by installing A boards as above. It is important to install these boards first and check all edges to ensure they are connecting the floor together correctly. Cut any "A" board to size that might be against a wall and installing your 6mm perimeter spacers as you progress.

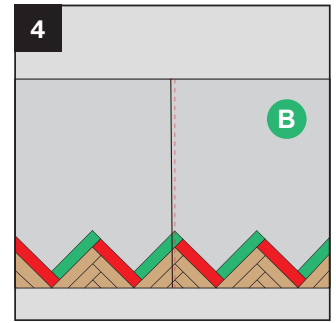

You can now install your "B" boards as shown above into your previously installed "A" boards. It is important after every row has been installed to check your flooring is running parallel to your installation wall, following the installation line. You might have to adjust as you go to ensure straightness is achieved.

Repeat steps 3&4 until you reach the far side of your room.

D Last Row Installation

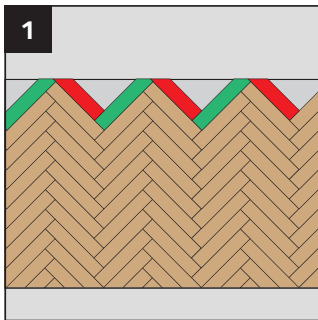

The alternating installation of "A" boards followed by "B" boards per row continues. However, you will need to start cutting boards to size to finish your installation. When cutting boards to size you must ensure you leave the correct gap for your spacers, keeping your expansion gap uniform around the full perimeter of your room.

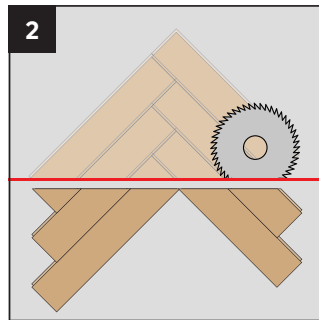

You can use the offcuts from your starting triangles to help finish your installation. This will minimise your waste from the installation.

E Finishing Off

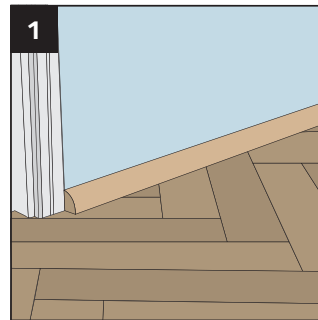

Once the floor is installed, remove the spacers; sweep the floor with a soft brush. Fix the skirting/base boards or suitable edge trim (available from your local distributor) to cover the expansion gaps. These should be attached to the wall, not the floor. This will allow your product to remain free to expand underneath the trim.

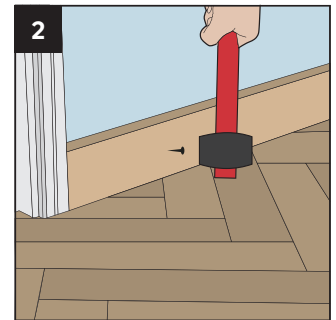

100% WATERPROOF AQUACORE BOARD

with PROFLEX Technology

UNIDROP
PATENTED TECHNOLOGY

HERRINGBONE INSTALLATION ENGINEERED SPC VINYL FLOORING



Furlong Flooring®
First choice flooring for every room

How to maintain your floor?

Daily Maintenance

For day-to-day cleaning, it is essential to dust your flooring with a microfibre mop or cloth each day to prevent any scratches and surface damage. Microfibre cleaning pads use static electricity to trap dirt, particles and other household allergens.

Dusting the surface will remove any particles of dust and grit that may appear from footwear and chair legs - This will prevent the floor from long-term damage. Household brushes may also be used, but please be aware that these can push the dirt around and potentially cause scratches to the floor's surface.

Weekly Maintenance

We recommend giving your floor a vacuum or damp mop weekly to remove more stubborn stains or debris that may have dried onto the surface.

When using a vacuum, pay close attention that there are no protruding parts around the tools that may cause damage to the surface of the floor.

Any excess water should be removed from the floor when using a mop. Never pour water directly onto the floor's surface, as this can cause swelling, warping, de-lamination and even joint separation. It will not only reduce the lifespan of your floor, and it will most likely void any manufacturer's warranty.



Steam Mops

We do **NOT** recommend using steam or wet mops on this floor, which will void the manufacturer's warranty.

100% WATERPROOF AQUACORE BOARD

with **PROFLEX** Technology

UNIDROP 
PATENTED TECHNOLOGY ®