

RUTLAND GUTTER SUPPLY LLC

sales@rutlandguttersupply.com Ph: 407-859-1119 Fax: 407-859-1123

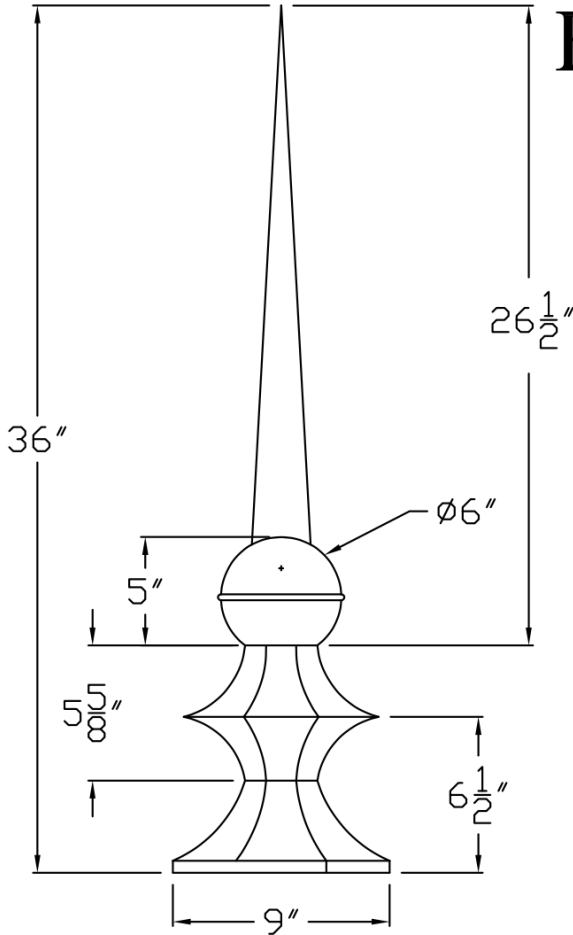

SIDE VIEW

FL039

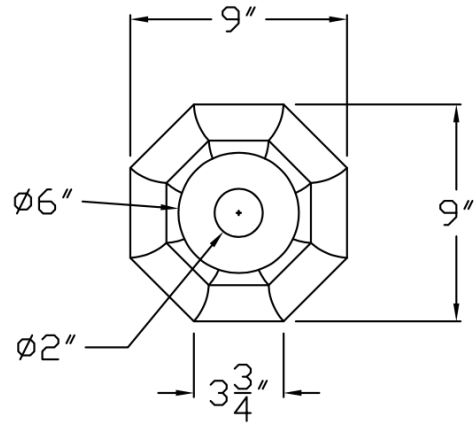







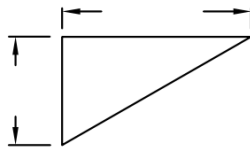
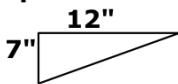



TOP VIEW

SPECIFY ROOF PITCH

To determine roof pitch:
 Use a straight edge at least 12" long,
 Put corner on roof, holding vertically
 level.
 At the 12" point, measure down. This
 is your roof pitch.
EXAMPLE:



SELECT ROOF SHAPE

- | | | | | |
|---|---|---|---|--|
| 
Flat Roof | 
Gable | 
Hip
Pyramid | 
Hip End
& Ridge | 
Cone Turret |
| 
5-Facet
Hip | 
6-Facet
Hip | 
7-Facet
Hip | 
Hexagon
Turret | 
Octagon
Turret |

Company:	Item: FL039
Invoice:	Material:
PO#:	Notes:
Architect:	
Contractor:	
Date:	
Approved by:	
Signature:	

CUSTOM ORDERS CAN NOT BE RETURNED